

LADDER RACK SYSTEM

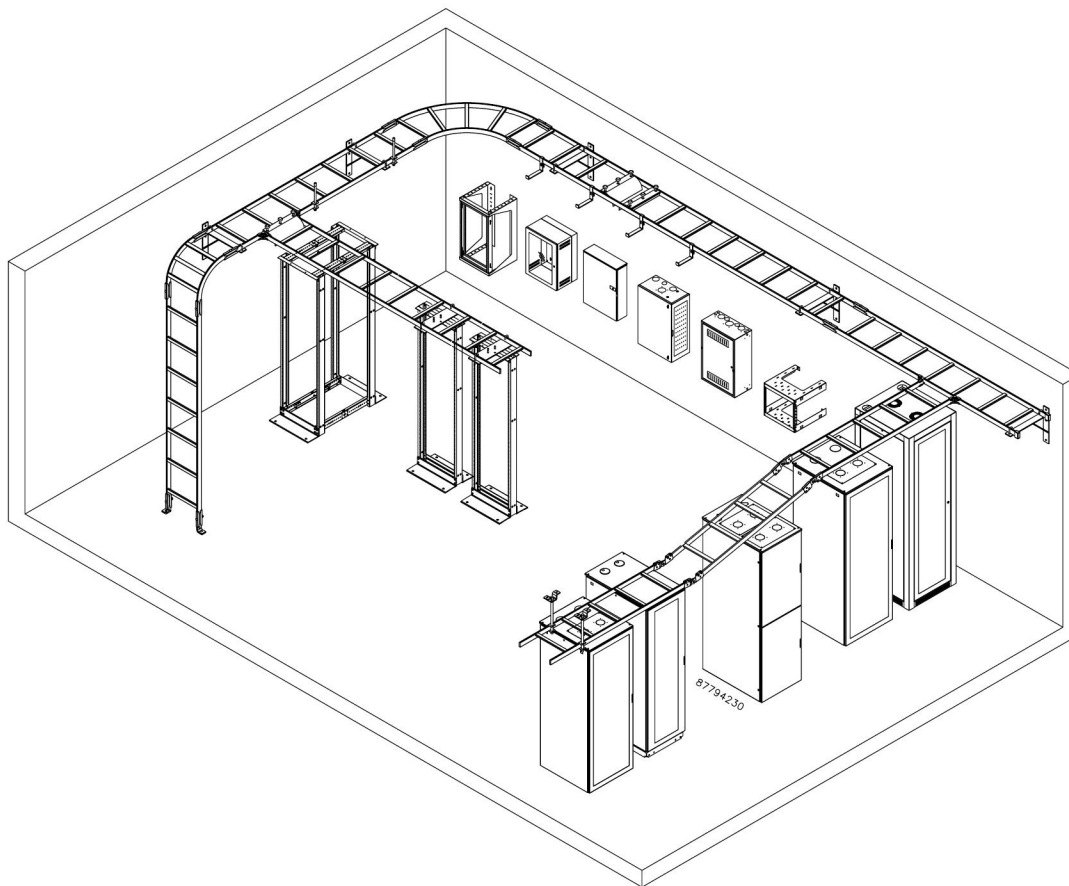

INDUSTRY STANDARDS

Painted and Plated Straight Sections:

UL/cULus Classified for Equipment Grounding and Load; File No. E236414

Curved Sections and Splice Kits:

UL/cULus Classified for Equipment Grounding; File No. E236414

cULus Bonding & Grounding

- Classified as suitable for an equipment ground conductor
 - **CSA C22.2 No. 126.1-02 Section 5.2.8 Load Destruction Test**
- Two grounding jumper kits required per each splice kit on painted ladder rack sections

cULus Load Testing

- Load capacity per 10 support lengths is 369.2 lb.; safety factor of 1.5X
 - **CSA C22.2 No. 126.1-02 Section 5.1 Electrical Continuity Test**

APPLICATION

The Ladder Rack System conveniently routes cables via a modular pathway through unused space on the floor, wall or ceiling while keeping cables accessible for easy maintenance. A variety of straight and curved sections are highly adaptable and can accommodate virtually any room layout.

FEATURES

- Section cross members welded on 9-in. (229-mm) centers
- Accessory adjustable cross members
- Butt-splice kits and junction-splice kits
- Each model is boxed or bagged

SPECIFICATIONS

- Straight and curved sections made of 1-1/2-in. steel
- Sections available in 6-, 12-, 15-, 18- and 24-in. (152-, 305-, 381-, 457- and 610-mm) widths
- Steel connecting and mounting hardware

FINISH

Available in four finishes:

- ANSI 61 gray polyester powder paint
- RAL 9005 black polyester powder paint
- White powder paint
- Plated

ACCESSORIES

Touch-up Paint



LADDER RACK STRAIGHT SECTIONS



cULus Classified

Supports cable on straight runs. Made of 1-1/2 in. x 3/8 in. (38 mm x 8 mm) 16 gauge tubular steel with a painted or plated finish. Nominal installed length is 10 ft. (3.05 m). Each section is 9 ft. 11-1/2 in. (3.03 m) long with cross members welded at 9-in. (229-mm) intervals.

BULLETIN: DCR

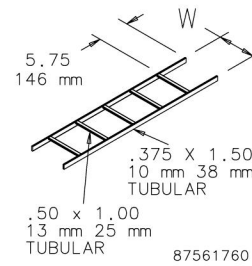

Catalog Number	Finish	W (in.)	W (mm)
LSS6G	Gray	6.00	152
LSS6BLK	Black	6.00	152
LSS6GZ	Plated	6.00	152
LSS6W	White	6.00	152
LSS12G	Gray	12.00	305
LSS12BLK	Black	12.00	305
LSS12GZ	Plated	12.00	305
LSS12W	White	12.00	305
LSS15W	White	15.00	381
LSS15BLK	Black	15.00	381
LSS18G	Gray	18.00	457
LSS18BLK	Black	18.00	457
LSS18W	White	18.00	457
LSS18GZ	Plated	18.00	457
LSS24BLK	Black	24.00	610
LSS24W	White	24.00	610

BUTT-SPLICE KIT



cULus Classified

Joins straight ladder rack sections, inside and outside bends, and 90-degree horizontal e-bends. Each kit connects one section to another. Includes mounting hardware.

BULLETIN: DCR

Catalog Number	Finish	Kit Qty.
LBSKG	Gray	2
LBSKB	Black	2
LBSK	Plated	2
LBSKW	White	2

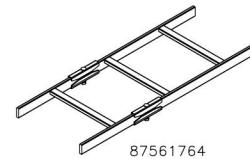

ADJUSTABLE BUTT-SPLICE KIT



cULus Classified

Provides a change in up-and-down direction of the cable runway. It can be adjusted to any angle from 0 to 90 degrees. Made of steel with a painted or plated finish. Each kit connects one ladder rack section to another. Includes mounting hardware.

BULLETIN: DCR

Catalog Number	Finish	Kit Qty.
LABSKG	Gray	2
LABSKB	Black	2
LABSK	Plated	2
LABSKW	White	2

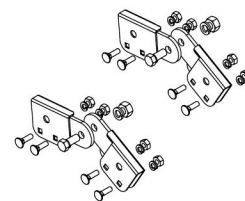

LADDER RACK CURVED SECTIONS

cULus Classified



Provide a vertical change in direction. They are made of 1-1/2 in. x 3/8 in. (38 mm x 8 mm) tubular steel with a painted or plated finish. Cross members are welded on the inside (inside bends) or outside (outside bends) of the section. Connect to straight section with butt-splice kits. Designed for category 5e, 6, 6A and fiber optic cable.

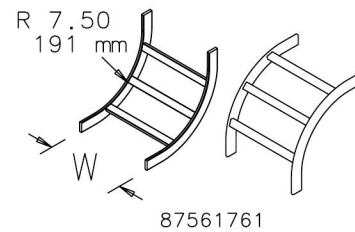

BULLETIN: DCR

Catalog Number	Finish	Vertical Bend Type	W (in.)	W (mm)
LIB6G	Gray	Inside	6.00	152
LIB6BLK	Black	Inside	6.00	152
LIB6GZ	Plated	Inside	6.00	152
LIB6W	White	Inside	6.00	152
LIB12G	Gray	Inside	12.00	305
LIB12BLK	Black	Inside	12.00	305
LIB12GZ	Plated	Inside	12.00	305
LIB12W	White	Inside	12.00	305
LIB15BLK	Black	Inside	15.00	381
LIB15W	White	Inside	15.00	381
LIB18G	Gray	Inside	18.00	457
LIB18BLK	Black	Inside	18.00	457
LIB18W	White	Inside	18.00	457
LIB18GZ	Plated	Inside	18.00	457
LIB24BLK	Black	Inside	24.00	610
LIB24W	White	Inside	24.00	610
LOB6G	Gray	Outside	6.00	152
LOB6BLK	Black	Outside	6.00	152
LOB6GZ	Plated	Outside	6.00	152
LOB6W	White	Outside	6.00	152
LOB12G	Gray	Outside	12.00	305
LOB12BLK	Black	Outside	12.00	305
LOB12GZ	Plated	Outside	12.00	305
LOB12W	White	Outside	12.00	305
LOB15BLK	Black	Outside	15.00	381
LOB15W	White	Outside	15.00	381
LOB18G	Gray	Outside	18.00	457
LOB18BLK	Black	Outside	18.00	457
LOB18GZ	Plated	Outside	18.00	457
LOB18W	White	Outside	18.00	457
LOB24BLK	Black	Outside	24.00	610
LOB24W	White	Outside	24.00	610

90-DEGREE HORIZONTAL E-BEND SECTION

cULus Classified



Provide a 90-degree horizontal change in cable runway direction. Made of 1-1/2 in. x 3/8 in. (38 mm x 8 mm) tubular steel with a painted or plated finish. Connect to straight sections with butt-splice kits. Designed for category 5e, 6, 6A and fiber optic cable.

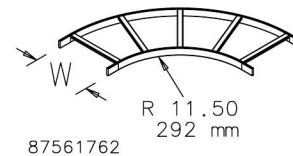

BULLETIN: DCR

Catalog Number	Finish	W (in.)	W (mm)
L90HB12G	Gray	12.00	305
L90HB12BLK	Black	12.00	305
L90HB12GZ	Plated	12.00	305
L90HB12W	White	12.00	305
L90HB15BLK	Black	15.00	381
L90HB15W	White	15.00	381
L90HB18G	Gray	18.00	457
L90HB18BLK	Black	18.00	457
L90HB18GZ	Plated	18.00	457
L90HB18W	White	18.00	457
L90HB24BLK	Black	24.00	610
L90HB24W	White	24.00	610

JUNCTION SPLICE KIT



cULus Classified

Connects two straight ladder rack sections at a 90-degree angle. Made of steel with a painted or plated finish. Each kit connects one section to another. Includes mounting hardware.

BULLETIN: DCR

Catalog Number	Finish	Kit Qty.
LJSKG	Gray	2
LJSKB	Black	2
LJSK	Plated	2
LJSKW	White	2

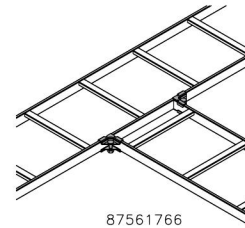

87561766

ADJUSTABLE JUNCTION SPLICE KIT



cULus Classified

Connects two ladder rack sections at any junction angle. Made of steel with a painted or plated finish. Each kit connects one section to another. Includes mounting hardware.

BULLETIN: DCR

Catalog Number	Finish	Kit Qty.
LAJSKG	Gray	2
LAJSKB	Black	2
LAJSK	Plated	2
LAJSKW	White	2

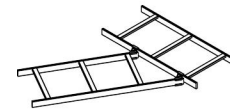

87561767

RETAINING POST KIT



Provides extra ladder rack capacity. Mounts onto rack side stringer. Post is unthreaded 1/2-in. tube. Kit components are plated steel. Includes post cap and mounting hardware.

BULLETIN: DCR

Catalog Number	Finish	Kit Qty.
LRP	Plated	1
LRPB	Black	1
LRPW	White	1

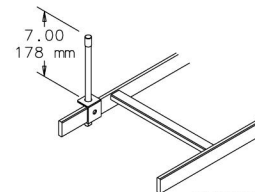

87561768

L-BRACKET KIT



The L-Bracket Kit supports power or other cables that need to be separated from the main cable run. Made of steel with a painted or plated finish. Mounts onto ladder rack stringer. Includes mounting hardware.

BULLETIN: DCR

Catalog Number	Finish	Kit Qty.
LLBG	Gray	1
LLBB	Black	1
LLB	Plated	1
LLBW	White	1

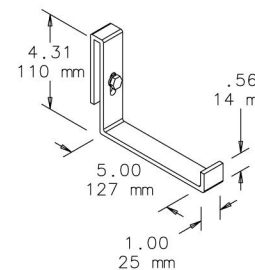

87561769

RADIUS DROP KIT



Mounts over ladder rack cross member to provide bending radius when dropping cable. Includes cable spools to separate cable and all mounting hardware. Made of extruded aluminum.

BULLETIN: DCR

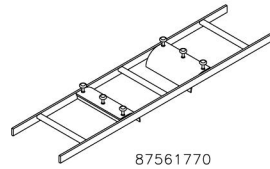

87561770

Catalog Number	Finish	Cable Runway Width (in.)	Cable Runway Width(mm)	Kit Qty.
LRD6G	Gray	6.00	152	1
LRD6BLK	Black	6.00	152	1
LRD6W	White	6.00	152	1
LRD12G	Gray	12.00	305	1
LRD12BLK	Black	12.00	305	1
LRD12W	White	12.00	305	1
LRD15BLK	Black	15.00	381	1
LRD15W	White	15.00	381	1
LRD18G	Gray	18.00	457	1
LRD18BLK	Black	18.00	457	1
LRD18W	White	18.00	457	1
LRD24BLK	Black	24.00	610	1
LRD24W	White	24.00	610	1

STRINGER RADIUS DROP KIT



Mounts over ladder rack stringer to provide bending radius when dropping cable. Includes cable spools to separate cable and all mounting hardware. Made of extruded aluminum.

BULLETIN: DCR

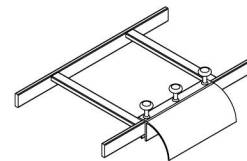

87561771

Catalog Number	Finish	Kit Qty.
LSRDG	Gray	1
LSRDBLK	Black	1
LSRDW	White	1

FOOT KIT



Secures ladder rack to floor, ceiling or wall. Made of steel with a painted or plated finish. One kit secures one ladder rack section. Requires surface mounting hardware (not included).

BULLETIN: DCR

Catalog Number	Finish	Kit Qty.
LFKG	Gray	2
LFKB	Black	2
LFK	Plated	2
LFKW	White	2

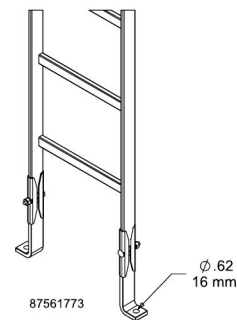

87561773

Ø .62
16 mm

CEILING SUPPORT KIT



Supports ladder rack from ceiling. Components available separately or as a kit. Six-foot-long, 5/8-in. diameter rod is threaded for easy tension adjustment. Made of plated steel. Requires surface mounting hardware (not included).

BULLETIN: DCR

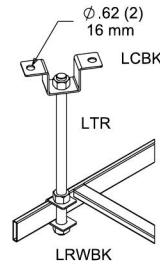

87561772

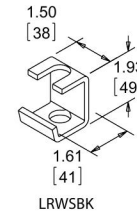

89059436

Catalog Number	Finish	Description	Kit Qty.
LCK	Plated	Kit includes one each: - LTR Threaded Rod - 5/8-in. nuts (4) - LRWBK Rack Runway Bracket - LCBK Ceiling Bracket	1
LTR	Plated	5/8-in. x 6-ft. Threaded Rod	1
LRWBK	Plated	Rack Runway Brackets (10) 5/8-in. nuts (20)	1
LRWBKB	Black	Rack Runway Brackets (10) 5/8-in. nuts (20)	1
LRWBKW	White	Rack Runway Brackets (10) 5/8-in. nuts (20)	1
LCBK	Plated	Ceiling Brackets (10) 5/8-in nuts (20)	1
LCBKB	Black	Ceiling Brackets (10) 5/8-in nuts (20)	1
LCBKW	White	Ceiling Brackets (10) 5/8-in nuts (20)	1
LRWSBK	Plated	Rack-to-Runway Brackets (10) Slip-On 5/8 in. nuts (20)	1
LRWSBKB	Black	Rack-to-Runway Brackets (20) Slip-On 5/8 in. nuts (40)	1
LRWSBKW	White	Rack-to-Runway Brackets (20) Slip-On 5/8 in. nuts (40)	1

RACK-TO-RUNWAY MOUNTING PLATE KIT



Secures ladder rack to the top of equipment racks. Made of steel with a painted or plated finish. The plate is designed for mounting either parallel or perpendicular to the rack. Includes mounting hardware.

BULLETIN: DCR

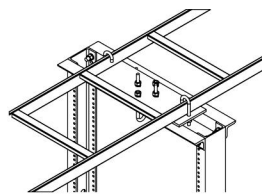

87561774

Catalog Number	Fits Ladder		Finish	Kit Qty.
	Width			
LRRMPG	6, 12		Gray	1
LRRMPBK	6, 12		Black	1
LRRMPGZ	6, 12		Plated	1
LRRMPW	6, 12		White	1
LRRMPW15	12, 15		White	1
LRRMPBK15	12, 15		Black	1
LRRMPG18	12, 18		Gray	1
LRRMPBK18	12, 18		Black	1
LRRMPGZ18	12, 18		Plated	1
LRRMPW18	12, 18		White	1
LRRMPBK24	18, 24		Black	1
LRRMPW24	18, 24		White	1

VERTICAL WALL BRACKET



Secures ladder rack section to wall or other flat surface. Made of steel with a painted or plated finish. Requires surface mounting hardware (not included).

BULLETIN: DCR

Catalog Number	Finish	Kit Qty.
LVWBG	Gray	2
LVWBB	Black	2
LVWB	Plated	2
LVWW	White	2

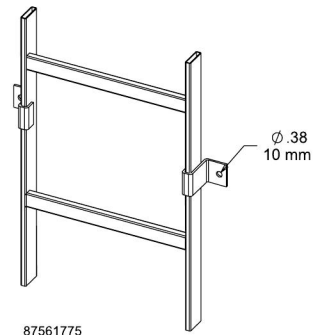

87561775

TRIANGLE SUPPORT BRACKET KIT



Supports ladder rack from wall. Bracket is made of steel with painted or plated finish. Brackets have predrilled mounting holes for two sizes of ladder rack. Includes one J-Bolt Kit.

BULLETIN: DCR

Catalog Number	Finish	Fits Cable Runway	Kit Qty.	Configuration
LTSB12G	Gray	6, 12	1	A
LTSB12BLK	Black	6, 12	1	A
LTSB12GZ	Plated	6, 12	1	A
LTSB12W	White	6, 12	1	A
LTSB181524W	White	15, 18, 24	1	A
LTSB151824BLK	Black	15, 18, 24	1	A
LTSB18G	Gray	12, 18	1	B
LTSB18BLK	Black	12, 18	1	B
LTSB18GZ	Plated	12, 18	1	B
LTSB24BLK	Black	12, 18, 24	1	A

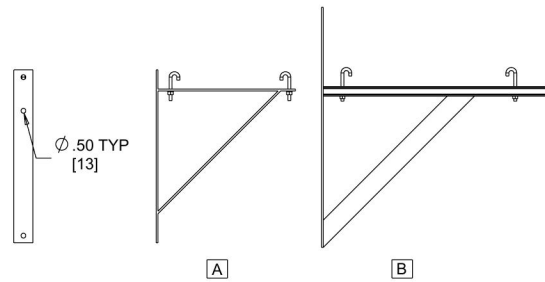

MODULAR TRIANGLE SUPPORT BRACKET KIT



Secures and supports ladder rack to wall. Design features three bracket support arms that easily attach to each other with quick-release pins and fold down to ease assembly. Each model accommodates two ladder rack widths. Kit includes one modular bracket assembly, three quick-release pins and two J-bolts with washers and nuts. Bracket made of painted steel with plated hardware.

BULLETIN: DCR

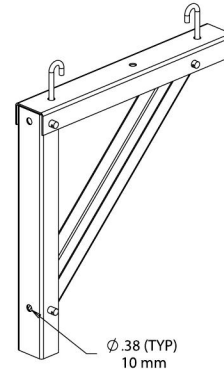

87929364

Catalog Number	Finish	Fits Cable Runway	Kit Qty.
LMTSB12B	Black	6, 12	1
LMTSB12W	White	6, 12	1
LMTSB18B	Black	12, 18	1
LMTSB18W	White	12, 18	1
LMTSB24B	Black	18, 24	1
LMTSB24W	White	18, 24	1

WALL ANGLE SUPPORT



Supports ladder rack from wall or other flat surface. Made of 2-in. x 2-in. 10 gauge steel angle with painted or plated finish. Includes two J-bolts, nuts and screws.

BULLETIN: DCR

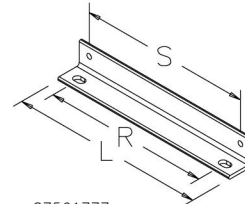

87561777

Catalog Number	Finish	L in./mm	R in./mm	S in./mm	Kit Qty.
LWASK6G	Gray	8.00 203	6.00 152	6.38 162	1
LWASK6BLK	Black	8.00 203	6.00 152	6.38 162	1
LWASK6GZ	Plated	8.00 203	6.00 152	6.38 162	1
LWASK12G	Gray	14.00 356	12.00 305	12.38 314	1
LWASK12BLK	Black	14.00 356	12.00 305	12.38 314	1
LWASK12GZ	Plated	14.00 356	12.00 305	12.38 314	1
LWASK12W	White	14.00 356	12.00 305	12.38 314	1
LWASK15W	White	17.00 432	15.00 381	15.38 391	1
LWASK15BLK	Black	17.00 432	15.00 381	15.38 391	1
LWASK18G	Gray	20.00 508	18.00 457	18.38 467	1
LWASK18BLK	Black	20.00 508	18.00 457	18.38 467	1
LWASK18GZ	Plated	20.00 508	18.00 457	18.38 467	1
LWASK18W	White	20.00 508	18.00 457	18.38 467	1
LWASK24BLK	Black	26.00 660	24.00 610	24.38 619	1
LWASK24W	White	26.00 660	24.00 610	24.38 619	1

CORNER SUPPORT BRACKET KIT



Provides additional support for 90-degree ladder rack junction. Made of steel with a painted or plated finish.

BULLETIN: DCR

Catalog Number	Kit Qty.	Finish
LCSKG	1	Gray
LCSKB	1	Black
LCSK	1	Plated
LCSKW	1	White

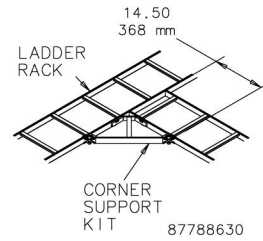

END CAP KIT



Provides protective covering for ends of ladder rack. Made of black vinyl.

BULLETIN: DCR

Catalog Number	Kit Qty.
LEC	2

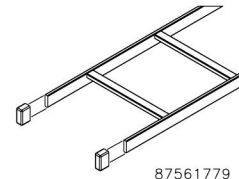

RUNWAY TERMINATION KIT



Provides a solid termination when the last section of ladder rack ends away from a wall. Made of steel with a painted or plated finish.

BULLETIN: DCR

Catalog Number	Finish	Fits Cable Runway	Kit Qty.
LRTK12G	Gray	12	1
LRTK12B	Black	12	1
LRTK12	Plated	12	1
LRTK12W	White	12	1
LRTK18G	Gray	18	1
LRTK18B	Black	18	1
LRTK18	Plated	18	1
LRTK18W	White	18	1
LRTK24B	Black	24	1
LRTK24W	White	24	1

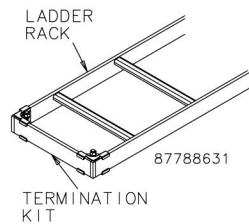

MOVABLE CROSS MEMBER



Supports cable at drop locations between welded cross members. Made of steel with a painted or plated finish. Includes hardware for secure mounting to ladder rack stringers.

BULLETIN: DCR

Catalog Number	Finish	W (in.)	W (mm)	Kit Qty.
LMCM12G	Gray	12.00	305	1
LMCM12BLK	Black	12.00	305	1
LMCM12GZ	Plated	12.00	305	1
LMCM12W	White	12.00	305	1
LMCM18G	Gray	18.00	457	1
LMCM18BLK	Black	18.00	457	1
LMCM18GZ	Plated	18.00	457	1
LMCM18W	White	18.00	457	1
LMCM24BLK	Black	24.00	610	1
LMCM24W	White	24.00	610	1

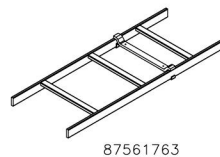

RACK-TO-WALL KIT

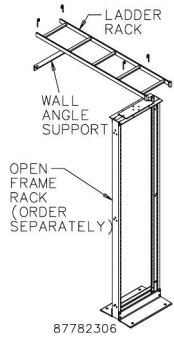

Includes one section of straight ladder rack and everything needed to fasten the ladder section to an open frame rack and to the wall. Ladder is 54-in. (1372-mm) long by 12-in. (305-mm) wide. All parts have a black painted finish. Order open frame rack separately.

BULLETIN: DOFR2

Catalog Number	Description
E45RUBKIT	Each Rack-to-Wall Kit includes one: - LST12BLK [54-in. (1372-mm) long] Ladder Rack* - LWASK12BLK Wall Angle Support with J-bolts - LRRMPBLK Rack-to-Runway Mounting Kit - LEC End Cap Kit

* Ladder Rack is cULus Classified

RUNWAY ELEVATION KIT



Elevates ladder rack 3 or 6 in. (76 or 152 mm) above rack-to-ladder mounting plate. Use on any width ladder rack. Kit includes two brackets and all mounting hardware. Made of heavy plated steel.

BULLETIN: DCR

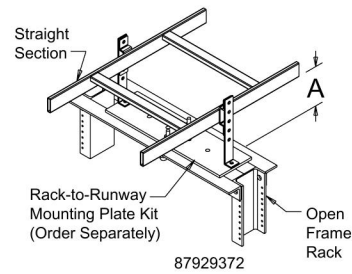

Catalog Number	A (in.)	A (mm)	Finish	Kit Qty.
LEK3	3.00	76	Plated	1
LEK3B	3.00	76	Black	1
LEK3W	3.00	76	White	1
LEK6	6.00	152	Plated	1
LEK6B	6.00	152	Black	1
LEK6W	6.00	152	White	1
LEK12	12.00	305	Plated	1
LEK12B	12.00	305	Black	1
LEK12W	12.00	305	White	1

RUNWAY OVERHEAD 12-IN. STACK KIT



Allows stacking any width of ladder rack runways 12 in. (305 mm) above each other. Each kit contains two complete stacking brackets with all necessary hardware. Use one kit at least every 5 ft. (1.5 m). Brackets and fasteners made of plated steel.

BULLETIN: DCR

Catalog Number	Finish	Includes	Kit Qty.
LST12	Plated	2 brackets and hardware	1
LST12B	Black	2 brackets and hardware	1
LST12W	White	2 brackets and hardware	1

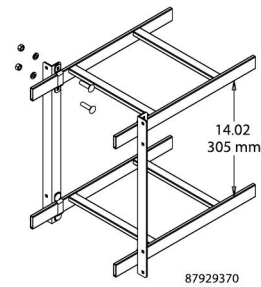

RUNWAY CENTER SUPPORT KIT



Threaded rod and bracket supports center of ladder rack from ceiling. Kit includes heavy-duty ladder rack cross member, two mounting brackets, two #12-24 screws, 5/8-in. threaded rod, protected sleeve and four 5/8-in. nuts. Use one kit at least every 5 ft. (1.5 m). Made of plated steel.

BULLETIN: DCR

Catalog Number	Finish	Fits Cable Runway	Kit Qty.
LCSK6	Plated	6	1
LCSK12	Plated	12	1
LCSK18	Plated	18	1
LCSK24	Plated	24	1

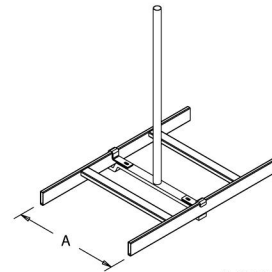

87929371

SPOOL DIVIDER KIT



Spools separate cables to improve cable management and to control cable-to-cable distances. Spool and bracket attach to ladder rack cross member and can be located anywhere across the width. Kit includes ten 4-in.-tall spools, brackets and all necessary hardware. Spool made of black plastic and bracket made of plated steel.

BULLETIN: DCR

Catalog Number	Finish	Kit Includes
LCRDSK	Black plastic spool; plated steel bracket	10 spools, 10 brackets and mounting hardware

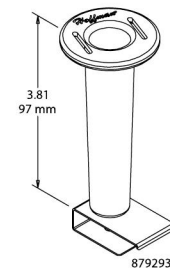

87929375

INSULATED GROUND JUMPER KIT

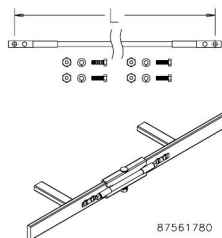

Fastens across splices to provide a secure ground between sections of ladder rack. Made of #6 AWG x 7 strand wire with green THW insulation and two-hole compression lugs mounted on each end. Includes fasteners.

BULLETIN: DBG

Catalog Number	Conductor Type	L in./mm
DGJ	#6-7 Stranded	12.00 305

cULus requires 2 kits per splice on all painted ladder sections

J-BOLT KIT

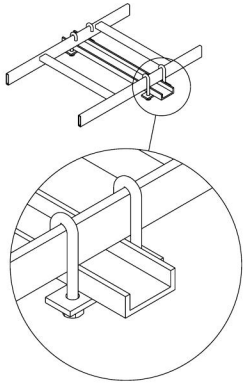

87561778

Connects ladder rack to top of cabinet or to auxiliary support channel. Kit includes two J-bolts and makes one support connection. Kit components are plated steel. Includes mounting hardware.

- Each kit contains:
- (2) J-Bolts, 5/16 in.
 - (2) Nuts, 5/16 in.
 - (2) Washers, 5/16 in.
 - (2) Lock Washers, 5/16 in.
 - (1) Plate

BULLETIN: DCR

Catalog Number	J (in.)	J (mm)	Finish
LJBK	3.5	89	Plated

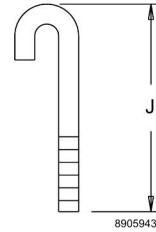

89059437

CABLERACK



CABLERACK is used for ladder or basket tray mounting and securing 19-inch rack equipment for server rooms, telecommunication rooms, and other applications. The fixed, open frame rack allows suspending 19-inch rack equipment from Ladder Rack or Basket Tray. The rack has universal tapped holes per industry standards to accommodate typical applications. These open frame racks are ideal for high-density cabling applications which require above-the-cabinet mounting of equipment, and provide maximum access to cables and equipment. In applications where equipment expands above the cabinet, CABLERACK provides ideal management with increased equipment and cable densities.

BULLETIN: DOFRW

Standard Product

Catalog Number	AxBxC in./mm	Rack Units	Cable Bend Radius Accessory
E19T6U	12.44 x 20.16 x 11.50 316 x 512 x 292	6	ECMBA4

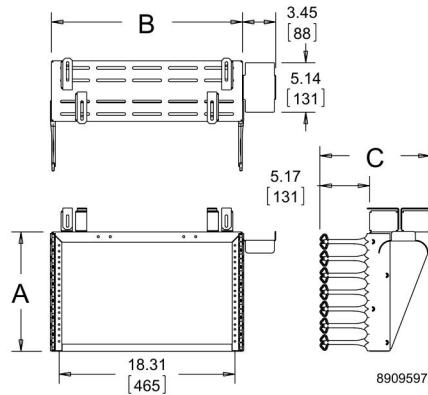

89095979